

Multistempel mit Schnellwechselsystem ohne Höhenverstellung im Ø 6 – 16 mm zur gleichzeitigen Kennzeichnung von z. B. 12 Monaten + 6 Jahren auf einem Stempel

Multi-stamp with fast-change system without height adjustment at Ø 6 – 16 mm for simultaneous identification of e.g. 12 months + 6 years on one stamp

DATI 9000

DATI®-BESCHREIBUNG DATI®-DESCRIPTION

- Hülse mit Kennzeichnung
- Stelleinheit mit Kennzeichnung und Schraubslot. Bestehend aus Stelleinsatz und Stelling. Positionierung über Steckprofil
- Befestigungsgewinde
- Spanneinheit, zum stufenlosen Arretieren des Stelleinsatzes
- Werkstoff: 1.4034, gehärtet HRC 56 ± 2 rostfrei
- Beschriftung spiegelbildlich

- Sleeve with identifier
- Adjustable unit with an identification and screw slot. Consisting of adjustable insert and adjustable ring. Positioning via plug profile
- Fastening thread
- Compression unit, for the infinite locking of the adjustable insert
- Material: 1.4034, hardened HRC 56 ± 2 stainless
- Inscription laterally reversed

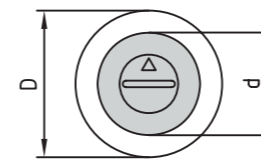
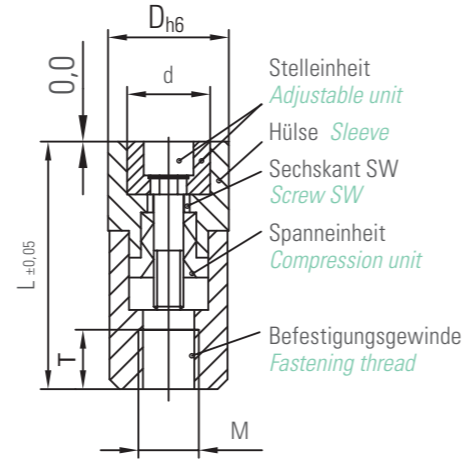

Maßtabelle in mm Dimension table in mm	
D	d
6	4,2
8	5,8
10	7,0
12	8,5
16	11,5

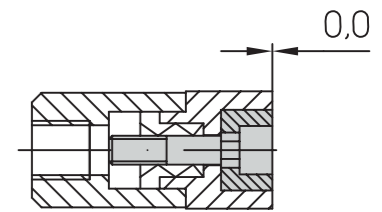

Montage Installation

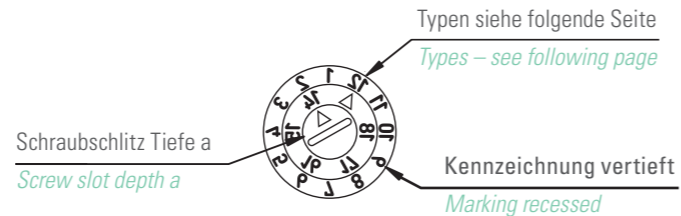
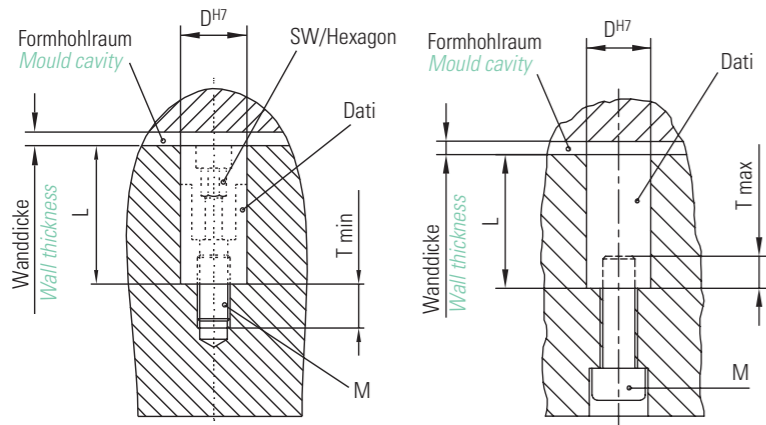

Maßtabelle in mm Dimension table in mm						
D	d	L	M	T	a	SW
6	4,2	17	3	3	0,40	2,5
8	5,8	20	4	4	0,40	3
10	7,0	20	5	4	0,40	3
12	8,5	25	6	6	0,60	4
16	11,5	33	8	8	0,60	5

Typ Type	BC	BCC	TA	WC				
Anzeige Indicator	12 Monate + 5 Jahre (Dez. 2014) Einstellung über Zwei-Pfeile-System <i>12 months + 5 years (Dec. 2014) adjustment with two-arrow-system</i>	12 Monate + 11 Jahre (Dez. 2015) Einstellung über Zwei-Pfeile-System <i>12 months + 11 years (Dec. 2015) adjustment with two-arrow-system</i>	30 Tage + 12 Monate + 1 Jahr (30. Dez. 2014) Einstellung über Zwei-Pfeile-System <i>30 days + 12 months + 1 year (30. Dec. '14) adjustment with two-arrow-system</i>	52 Wochen + 5 Jahre (Woche 40/2014) Einstellung über Zwei-Pfeile-System <i>52 weeks + 5 years (week 40/2014) adjustment with two-arrow-system</i>				
D	Bestell-Nr. Order no.	Euro	Bestell-Nr. Order no.	Euro	Bestell-Nr. Order no.	Euro	Bestell-Nr. Order no.	Euro
6	BC/9006/Jahr(Year)+4	80,00	BCC/9006/Jahr(Year)+10	80,00	TA/9006/Jahr(Year)	80,00	WC/9006/Jahr(Year)+4	80,00
8	BC/9008/Jahr(Year)+4	80,00	BCC/9008/Jahr(Year)+10	80,00	TA/9008/Jahr(Year)	80,00	WC/9008/Jahr(Year)+4	80,00
10	BC/9010/Jahr(Year)+4	80,00	BCC/9010/Jahr(Year)+10	80,00	TA/9010/Jahr(Year)	80,00	WC/9010/Jahr(Year)+4	80,00
12	BC/9012/Jahr(Year)+4	85,00	BCC/9012/Jahr(Year)+10	85,00	TA/9012/Jahr(Year)	85,00	WC/9012/Jahr(Year)+4	85,00
16	BC/9016/Jahr(Year)+4	85,00	BCC/9016/Jahr(Year)+10	85,00	TA/9016/Jahr(Year)	85,00	WC/9016/Jahr(Year)+4	85,00

Stelleinheiten DATI 9000 Adjustable units DATI 9000

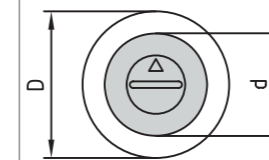

Bestellbeispiel: FCC/9006/14+10
Ordering example: FCC/9006/14+10

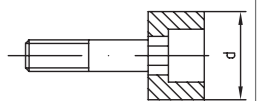

SCHNELLWECHSELSYSTEM FAST CHANGING SYSTEM			
<p>Beispiel: Jahr 14 Example: year 14</p>	<p>Stelleinheit einstellen:</p> <ul style="list-style-type: none"> • Stelleinsatz und Stelling auf gewünschte Position zusammenfügen <p>To adjust adjustable unit:</p> <ul style="list-style-type: none"> • Turn adjustable insert and adjustable ring to desired position 	<p>Beispiel: Monat 12 Example: month 12</p>	<p>Beispiel: Monat 12 Example: month 12</p>
	<p>Stelleinheit eindrehen:</p> <ul style="list-style-type: none"> • In Hülse rechts eindrehen • Maximal bis Anschlag • Automatische Spannung • Spannungsbereich 3 – 5 Umdrehungen <p>To screw in adjustable unit:</p> <ul style="list-style-type: none"> • Turn clockwise into sleeve • Max to end position • Tenses automatically • Tensioning range 3 – 5 turns 	<p>Stelleinheit verdrehen:</p> <ul style="list-style-type: none"> • Im Spannungsbereich rechts und links drehbar • Gewünschte Position einstellen • Bei Bedarf durch Drehen nach rechts nachspannen <p>To change adjustable unit:</p> <ul style="list-style-type: none"> • Can be turned clockwise and counter-clockwise • Set desired position • Re-clamp if necessary by turning clockwise 	<p>Beispiel: Monat 12 Example: month 12</p>

Typ Type	WCC	FC	FCC	FA	F					
Anzeige Indicator	52 Wochen + 11 Jahre (Woche 51/2014) Einstellung über Zwei-Pfeile-System <i>52 weeks + 11 years (week 51/2014) adjustment with two-arrow-system</i>	5 Jahre (2014) Für Typ BC, WC <i>5 years (2014) for type BC, WC</i>	11 Jahre (2014) Für Typ BCC, WCC <i>11 years (2014) for type BCC, WCC</i>	12 Monate + 1 Jahr (Dez. 2014) Für Typ TA <i>12 months + 1 year (Dec. 2014) for type TA</i>	Stelleinsatz mit Pfeil + Jahr <i>Adjustable inserts with arrow + year</i>					
D	Bestell-Nr. Order no.	Euro	Bestell-Nr. Order no.	Euro	Bestell-Nr. Order no.	Euro	Bestell-Nr. Order no.	Euro		
6	WCC/9006/Jahr(Year)+10	80,00	FC/9006/Jahr(Year)+4	40,00	FCC/9006/Jahr(Year)+10	40,00	FA/9006/Jahr(Year)	40,00	F/9006/Jahr(Year)	20,00
8	WCC/9008/Jahr(Year)+10	80,00	FC/9008/Jahr(Year)+4	40,00	FCC/9008/Jahr(Year)+10	40,00	FA/9008/Jahr(Year)	40,00	F/9008/Jahr(Year)	20,00
10	WCC/9010/Jahr(Year)+10	80,00	FC/9010/Jahr(Year)+4	40,00	FCC/9010/Jahr(Year)+10	40,00	FA/9010/Jahr(Year)	40,00	F/9010/Jahr(Year)	20,00
12	WCC/9012/Jahr(Year)+10	85,00	FC/9012/Jahr(Year)+4	45,00	FCC/9012/Jahr(Year)+10	45,00	FA/9012/Jahr(Year)	45,00	F/9012/Jahr(Year)	22,00
16	WCC/9016/Jahr(Year)+10	85,00	FC/9016/Jahr(Year)+4	45,00	FCC/9016/Jahr(Year)+10	45,00	FA/9016/Jahr(Year)	45,00	F/9016/Jahr(Year)	22,00