



DATI®-BESCHREIBUNG DATI®-DESCRIPTION

- Hülse mit Kennzeichnung
- Stelleinsatz mit Anzeigepfeil
- Befestigungs- / Spanschraube
- Werkstoff für Hülse und Stelleinsatz Messing oder 1.2510, gehärtet HRC 54 ± 2
- Beschriftung spiegelbildlich **erhaben** bei Dati 4000 und 4400
- Beschriftung spiegelbildlich **vertieft** bei Dati 4500 und 4600
- Sleeve with identifier
- Adjustable insert with an indicator arrow
- Mounting- / setscrew
- Material for sleeve and adjustable insert brass or 1.2510, hardened HRC 54 ± 2
- Inscription laterally reversed **raised** with Dati 4000 and 4400
- Inscription laterally reversed **recessed** with Dati 4500 and 4600

Dati 4400 aus Ms 58 | Dati 4000 aus 1.2510 HRC 54 Gravur erhaben
 Dati 4400 from Ms 58 | Dati 4000 from 1.2510 HRC 54 engraving raised

Dati 4600 aus Ms 58 | Dati 4500 aus 1.2510 HRC 54 Gravur vertieft
 Dati 4600 from Ms 58 | Dati 4500 from 1.2510 HRC 54 engraving recessed

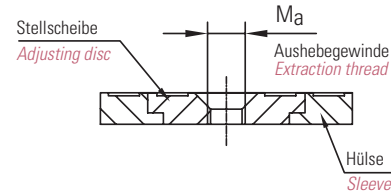
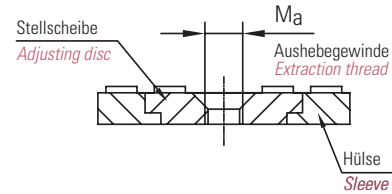
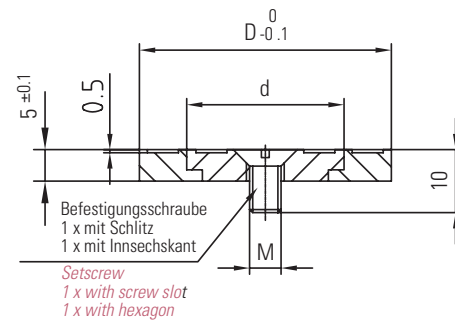
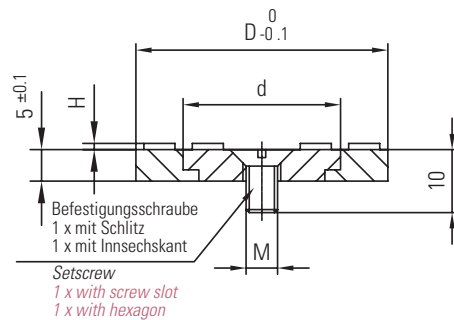

Einbaubeispiele:
 Installation examples:

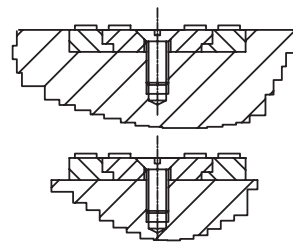

Maßtabelle in mm Dimension table in mm				
D	d	M	Ma	H
15	10	3	4	0,5
20	13	3	4	1
30	19	4	5	1
40	25	5	6	1

SCHNELLWECHSELSYSTEM FAST CHANGING SYSTEM

Typ	Anzeige	D	Bestell-Nr.	Euro	Bestell-Nr.	Euro	Bestell-Nr.	Euro	Bestell-Nr.	Euro
A	Monate + Jahr (z. B. Januar 14) Months + year (e.g. january 14)	15	A/4415/Jahr(Year)	45,00	B/4415/00	45,00	C/4415/Jahr(Year)+5	45,00	T/4415/00	48,00
B	Monate + Jahr (z. B. Januar) Months + year (e.g. january)	20	A/4420/Jahr(Year)	45,00	B/4420/00	45,00	C/4420/Jahr(Year)+5	45,00	T/4420/00	48,00
C	Jahr + 5 Jahre (verbunden mit Typ B zeigt z. B. Januar 14) Year + 5 years (in combination with type B displays e.g. january 14)	30	A/4430/Jahr(Year)	58,00	B/4430/00	58,00	C/4430/Jahr(Year)+5	58,00	T/4430/00	62,00
T	Tage 1 – 31 (verbunden mit Typ A zeigt z. B. 25.01.14, verbunden mit Typ B+C zeigt z. B. 25.01.2014 plus weitere 5 Jahre) Days 1 – 31 (in combination with type A displays 25.01.14, in combination with type B + C displays e.g. 25.01.14 plus additional 5 years)	40	A/4440/Jahr(Year)	68,00	B/4440/00	68,00	C/4440/Jahr(Year)+5	68,00	T/4440/00	72,00
F	Pfeil + Jahr Arrow + year		F/4415/Jahr(Year)	19,00	F/4420/Jahr(Year)	19,00	F/4430/Jahr(Year)	25,00	F/4440/Jahr(Year)	29,00

Stelleinsatz befestigen:
 • Hülse und Stellscheibe einlegen
 • Mit Befestigungs- / Spanschraube arretieren

To screw in adjustable insert:
 • Insert sleeve and adjusting disc
 • Secure with mounting / setscrew

Stelleinsatz verdrehen:
 • Spanschraube lösen
 • Gewünschte Position einstellen
 • Spanschraube wieder festziehen

To turn adjustable insert:
 • Unfasten setscrew
 • Set desired position
 • Secure setscrew

Stelleinsatz wechseln:
 • Befestigungsschraube lösen
 • Stelleinsatz mittels Aushebebinde entnehmen

To change adjustable insert:
 • Unfasten mounting screw
 • Remove adjusting inset with the help of extraction thread

DATI 4000





Werkstoff: 1.2510 HRC 54 Gravur erhaben Material: 1.2510 HRC 54 raised engraving									
Typ	A	B	C	T	F				
Anzeige	Monate + Jahr (z. B. Januar 14) Months + year (e.g. january 14)	Monate + Jahr (z. B. Januar) Months + year (e.g. january)	Jahr + 5 Jahre (verbunden mit Typ B zeigt z. B. Januar 14) Year + 5 years (in combination with type B displays e.g. january 14)	Tage 1 – 31 (verbunden mit Typ A zeigt z. B. 25.01.14, verbunden mit Typ B+C zeigt z. B. 25.01.2014 plus weitere 5 Jahre) Days 1 – 31 (in combination with type A displays 25.01.14, in combination with type B + C displays e.g. 25.01.14 plus additional 5 years)	Pfeil + Jahr Arrow + year				
D	Bestell-Nr. Order no.	Bestell-Nr. Order no.	Bestell-Nr. Order no.	Bestell-Nr. Order no.	Bestell-Nr. Order no.				
15	A/4015/Jahr(Year)	B/4015/00	C/4015/Jahr(Year)+5	T/4015/00	F/4015/Jahr(Year)				
20	A/4020/Jahr(Year)	B/4020/00	C/4020/Jahr(Year)+5	T/4020/00	F/4020/Jahr(Year)				
30	A/4030/Jahr(Year)	B/4030/00	C/4030/Jahr(Year)+5	T/4030/00	F/4030/Jahr(Year)				
40	A/4040/Jahr(Year)	B/4040/00	C/4040/Jahr(Year)+5	T/4040/00	F/4040/Jahr(Year)				

DATI 4400

Werkstoff: Ms 58 (CuZn39Pb2) Gravur erhaben Material: Ms 58 (CuZn39Pb2) raised engraving									
Typ	A	B	C	T	F				
Anzeige	Monate + Jahr (z. B. Januar 14) Months + year (e.g. january 14)	Monate + Jahr (z. B. Januar) Months + year (e.g. january)	Jahr + 5 Jahre (verbunden mit Typ B zeigt z. B. Januar 14) Year + 5 years (in combination with type B displays e.g. january 14)	Tage 1 – 31 (verbunden mit Typ A zeigt z. B. 25.01.14, verbunden mit Typ B+C zeigt z. B. 25.01.2014 plus weitere 5 Jahre) Days 1 – 31 (in combination with type A displays 25.01.14, in combination with type B + C displays e.g. 25.01.14 plus additional 5 years)	Pfeil + Jahr Arrow + year				
D	Bestell-Nr. Order no.	Bestell-Nr. Order no.	Bestell-Nr. Order no.	Bestell-Nr. Order no.	Bestell-Nr. Order no.				
15	A/4415/Jahr(Year)	B/4415/00	C/4415/Jahr(Year)+5	T/4415/00	F/4415/Jahr(Year)				
20	A/4420/Jahr(Year)	B/4420/00	C/4420/Jahr(Year)+5	T/4420/00	F/4420/Jahr(Year)				
30	A/4430/Jahr(Year)	B/4430/00	C/4430/Jahr(Year)+5	T/4430/00	F/4430/Jahr(Year)				
40	A/4440/Jahr(Year)	B/4440/00	C/4440/Jahr(Year)+5	T/4440/00	F/4440/Jahr(Year)				



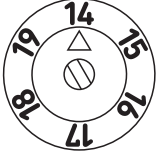

DATI 4500

Werkstoff: 1.2510 HRC 54 Gravur vertieft Material: 1.2510 H R C 54 recessed engraving

Typ Type	A		B		C		T		F	
						Anzeige Indicator		Anzeige Indicator		Anzeige Indicator
Monate + Jahr (z. B. Januar 14) <i>Months + year (e.g. january 14)</i>		Monate + Jahr (z. B. Januar) <i>Months + year (e.g. january)</i>		Jahr + 5 Jahre (verbunden mit Typ B zeigt z. B. Januar 14) <i>Year + 5 years (in combination with type B displays e.g. january 14)</i>		Tage 1 – 31 (verbunden mit Typ A zeigt z. B. 25.01.14, verbunden mit Typ B+C zeigt z. B. 25.01.2014 plus weitere 5 Jahre) <i>Days 1 – 31 (in combination with type A displays 25.01.14, in combination with type B + C displays e.g. 25.01.14 plus additional 5 years)</i>		Pfeil + Jahr <i>Arrow + year</i>		
D	Bestell-Nr. Order no.	Euro	Bestell-Nr. Order no.	Euro	Bestell-Nr. Order no.	Euro	Bestell-Nr. Order no.	Euro	Bestell-Nr. Order no.	Euro
15	A/4515/Jahr(Year)	55,00	B/4515/00	55,00	C/4515/Jahr(Year)+5	55,00	T/4515/00	59,00	F/4515/Jahr(Year)	18,00
20	A/4520/Jahr(Year)	55,00	B/4520/00	55,00	C/4520/Jahr(Year)+5	55,00	T/4520/00	59,00	F/4520/Jahr(Year)	18,00
30	A/4530/Jahr(Year)	59,00	B/4530/00	59,00	C/4530/Jahr(Year)+5	59,00	T/4530/00	62,00	F/4530/Jahr(Year)	22,00
40	A/4540/Jahr(Year)	68,00	B/4540/00	68,00	C/4540/Jahr(Year)+5	68,00	T/4540/00	70,00	F/4540/Jahr(Year)	28,00

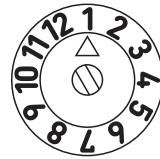
DATI 4600

Werkstoff: Ms 58 (CuZn39Pb2) Gravur vertieft Material: Ms 58 (CuZn39Pb2) recessed engraving

Typ Type	A		B		C		T		F	
						Anzeige Indicator		Anzeige Indicator		Anzeige Indicator
Monate + Jahr (z. B. Januar 14) <i>Months + year (e.g. january 14)</i>		Monate + Jahr (z. B. Januar) <i>Months + year (e.g. january)</i>		Jahr + 5 Jahre (verbunden mit Typ B zeigt z. B. Januar 14) <i>Year + 5 years (in combination with type B displays e.g. january 14)</i>		Tage 1 – 31 (verbunden mit Typ A zeigt z. B. 25.01.14, verbunden mit Typ B+C zeigt z. B. 25.01.2014 plus weitere 5 Jahre) <i>Days 1 – 31 (in combination with type A displays 25.01.14, in combination with type B + C displays e.g. 25.01.14 plus additional 5 years)</i>		Pfeil + Jahr <i>Arrow + year</i>		
D	Bestell-Nr. Order no.	Euro	Bestell-Nr. Order no.	Euro	Bestell-Nr. Order no.	Euro	Bestell-Nr. Order no.	Euro	Bestell-Nr. Order no.	Euro
15	A/4615/Jahr(Year)	38,00	B/4615/00	38,00	C/4615/Jahr(Year)+5	38,00	T/4615/00	40,00	F/4615/Jahr(Year)	15,00
20	A/4620/Jahr(Year)	38,00	B/4620/00	38,00	C/4620/Jahr(Year)+5	38,00	T/4620/00	40,00	F/4620/Jahr(Year)	15,00
30	A/4630/Jahr(Year)	48,00	B/4630/00	48,00	C/4630/Jahr(Year)+5	48,00	T/4630/00	50,00	F/4630/Jahr(Year)	17,00
40	A/4640/Jahr(Year)	58,00	B/4640/00	58,00	C/4640/Jahr(Year)+5	58,00	T/4640/00	60,00	F/4640/Jahr(Year)	18,00